

## EMC SUPPRESSORS

### Suppression modules for inductive loads simplify the fulfilment of the EMC law!

Old laws have not lost their validity now. The Ohm's law is still valid everywhere, as well as the Lenz's rule. This states that when an inductive load is switched off, current has the desire to continue flowing in the same direction and strength as before. A voltage source is created from the inductive load, which can be many times higher than the nominal voltage. This voltage spike is the cause of many EMC problems.

### What does the EMC law achieve?

From the 1st January 1996 only products which fulfil the requirements of § 4 of the EMC guidelines, can be brought into the European market.

That means:

Products cannot send out interference nor be influenced by it. Suppression components do not fall under the EMC guidelines.

### Reasons for interferences

#### – High inductive voltage spikes at inductive loads:

The high voltage spikes when switching off exceed the normal supply voltage many times and overload the electronics. The voltage can in some cases be so high, that the windings are shorted and the inductive component is destroyed.

#### – High inductive voltage spikes in the automated system:

The voltage spikes climb at a very high speed. These very high climb rates contain high frequencies. Every cable and wire in the control system acts as a transmitter or receiver for these high frequencies.

These high frequency interferences can therefore move unhindered from cable to neighboring cable.

#### – High inductive voltage spikes in the controller:

The present voltage spike at the moment of switching off adds itself in opposite polarity to the supply voltage and affects the controller i.e. PLC.

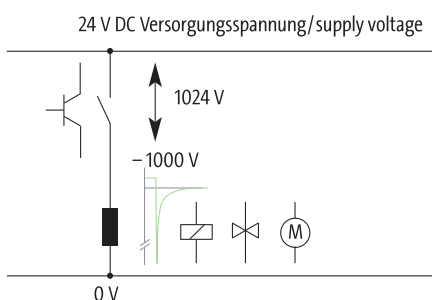

These high voltages in the controller cause energy rich arcs, due to the current flowing on in the same strength and direction at the moment that the contact is opened.

The arcs cause material deformation and reduce the life expectancy of the switching elements.

### Murrelektronik solves your interference problems

- Faults in the control process
- Defective control system
- Defective coil on the motor, contactor, valve or transformer
- Interference emissions causing a reduction in functionality
- EMC problems

### Suppression modules for control systems

Murrelektronik supply suppressors for all standard inductive loads.

#### For contactors

- Integrated system solutions for all common protectors
- Contactors or relays for universal suppressors can be snapped onto DIN-rail

#### For motors

- Direct suppression inside the motor terminal box
- Motor connection socket 10 + E with integrated suppression and manufactured cable
- Integrated system solutions for direct mounting
- The universal suppressors should be mounted near the source of interference (motor)

#### For valves

- Easy mounting of suppressor.

### Advantage:

- Optimum interference through individual adaption
- Easy mounting through prefabricated modules – always the perfect solution
- Less breakdowns increase availability and reduce downtime
- High life span of contacts and control units reduces maintenance cost

## An overview of different types of suppressors

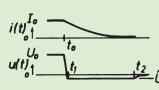
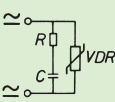
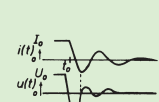
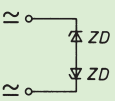
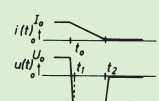
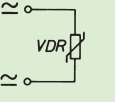
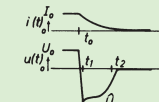
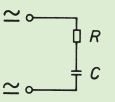
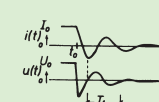
Circuit	Characteristics of load current and voltages	Incorrect polarity protection and also suitable for AC	Additional switch-off delay	Back e. m. f. limitation	Damping also occurs below $U_{LIMIT}$	Remarks
		no	very large	1 V	no	Advantages: <ul style="list-style-type: none"> <li>Matches wide range of loads</li> <li>Best possible damping</li> <li>Simple construction</li> </ul> Disadvantages: <ul style="list-style-type: none"> <li>Long delay time</li> </ul>
		yes	small	$U_{VDR}$	yes	Advantages: <ul style="list-style-type: none"> <li>HF-damping due to RC-network</li> <li>High energy absorption</li> <li>Short delay time</li> </ul> Disadvantages: <ul style="list-style-type: none"> <li>Must be matched to the load</li> <li>Limited lifespan</li> </ul>
		yes	small	$U_{ZD}$	no	Advantages: <ul style="list-style-type: none"> <li>Limits positive and negative voltages</li> <li>Suitable for AC and DC</li> <li>Matches wide range of loads</li> </ul> Disadvantages: <ul style="list-style-type: none"> <li>No damping below <math>U_{ZD}</math></li> </ul>
		yes	small	$U_{VDR}$	no	Advantages: <ul style="list-style-type: none"> <li>Matches wide range of loads</li> <li>High energy absorption</li> <li>Very simple construction</li> </ul> Disadvantages: <ul style="list-style-type: none"> <li>No damping below <math>U_{VDR}</math></li> <li>Limited lifespan</li> </ul>
		yes	small	$1.5 \times U_{NOM}$	yes	Advantages: <ul style="list-style-type: none"> <li>HF-damping due to RC-network</li> <li>Immediate de-energization</li> <li>Excellent results with AC</li> </ul> Disadvantages: <ul style="list-style-type: none"> <li>Must be matched to the load</li> <li>Limited lifespan</li> </ul>

### EMC Suppressors for contactors

For all common manufacturers the integrated system solution.



To attenuate high voltage switch off overloads, which lead to contact burn out and destruction of the neighboring electronic control systems, contactors should be suppressed.

Murrelektronik has for years developed and produced suppression modules, which are carefully designed together with the contactor manufactures, to work with specific contactors.

The mechanical mounting of the modules is therefore exact and simple as well as guaranteeing the optimum suppression characteristics.

Connection is via flexible wires or direct contacts.

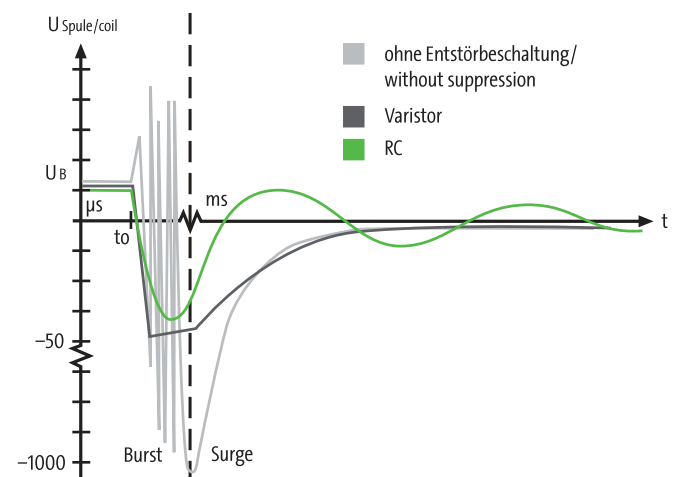

# EMC SUPPRESSORS

## Suppressors for motors

We offer a suitable motor suppressor for every application. The suppressor should, if at all possible be mounted very close to the source of interference (motor). The European norm (EN 50262) has been valid since 31st December 1999 for metric threads and replaces the DIN 46320 for PG threads. There are also modules available which can be snapped onto DIN-rail.

The use of motor suppression equipment protects the motor from high inductive voltage spikes when switching off. At the same time, it increases the contact life span of the control unit.

With the optimum suppression modules from Murrelektronik, you receive the highest level of operational safety. The machine or control panel will function within the EMC regulations, without affecting other electrical equipment in the surrounding area.

## Suppression at the motor terminal box

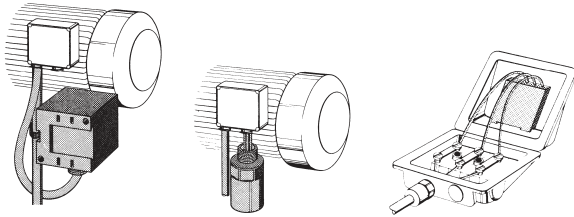

Suppression, where the interference arises!

## Mounts directly on the motor

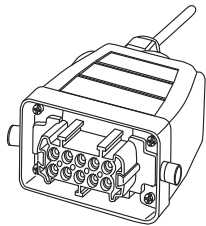

“Plugged in - what else”

## Snap-on under the contactor

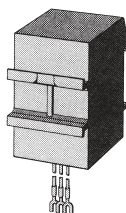

## Space savings

## Suppressors for valves

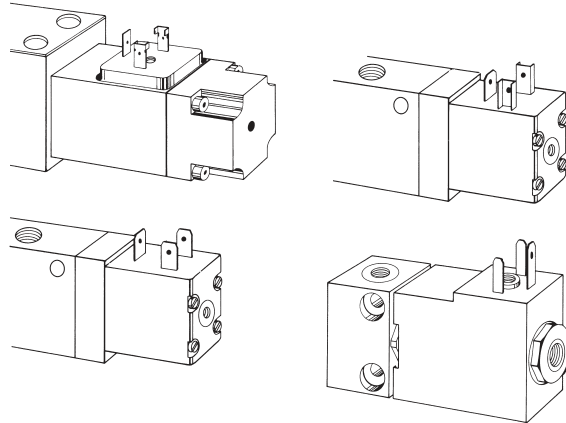

## For every form a suitable suppression

Hydraulic and pneumatic systems are an integral part of most machines. The plug supplied is often not enough to meet the standards many applications require. Suppression is necessary for the machines functionality and a LED vital for fault-finding and maintenance.

### Advantage:

- Simple plug-on mounting without any wiring
- Suitable adapter for all standard valves
- Protects the control system using the optimal network
- LED in yellow
- Adapter polarity safe for all voltages

Field wireable and pre-wired valve connector with LED and suppression see chapter 3.9

## EMC SUPPRESSORS

For contactors

Further variants on request. See Murrelektronik Shop [onlineshop.murrelektronik.com](http://onlineshop.murrelektronik.com)



**ABB contactors**

page 1.9.7



**General Electric contactors**

from page 1.9.8



**Moeller contactors**

from page 1.9.9



**Omron contactors**

page 1.9.11



**Rockwell A.B. contactors**

page 1.9.12



**Schneider-Telemecanique contactors**

page 1.9.13



**Siemens contactors**

from page 1.9.14



**Universal suppressors**

from page 1.9.17

## EMC SUPPRESSORS

For motors, mounting directly at the motor

Further variants on request. See [Murrelektronik Shop onlineshop.murrelektronik.com](http://Murrelektronik Shop onlineshop.murrelektronik.com)



### RC 3 U

Mounting universal or directly at the terminal box

page 1.9.19



### RC 3 R

Mounting at the terminal box

page 1.9.20



### RC 3 ST

Motor connectoin plug with integrated suppression and prewired cable

page 1.9.21

For motors, mounting at the control panel

Further variants on request. See [Murrelektronik Shop onlineshop.murrelektronik.com](http://Murrelektronik Shop onlineshop.murrelektronik.com)



### RC 3 BUR

Mounting directly in contactors

page 1.9.22



### HRC 3 AS

Space savings on DIN-rail mounting

page 1.9.23



### RC 3 RT

For Siemens SIRIUS contactor

page 1.9.23

## EMC SUPPRESSORS

For valves

Valve diagram

Further variants on request. See Murrelektronik Shop [onlineshop.murrelektronik.com](http://onlineshop.murrelektronik.com)



VBS

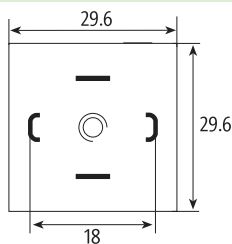

**Form A, acc. to EN 175301-803 (ISO 4400)**

Pin spacing 18 mm, square

2 springs for PE-contact

page 1.9.24



DAB

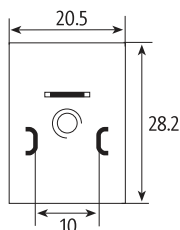

**Form B, acc. to EN 175301-803 (ISO 6952)**

Pin spacing 10 mm, narrow

2 springs for PE-contact

page 1.9.25



LBS



PBS

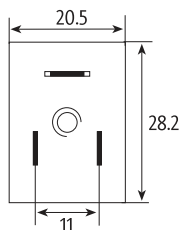

**Form BI, Industrial standard**

Pin spacing 11 mm, narrow  
for plug with PE at cable entry

page 1.9.24 and 1.9.25



MVK

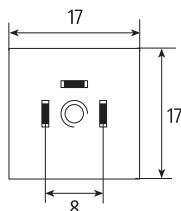

**Form C, acc. to EN 175301-803 (ISO 6952)**

Pin spacing 8.0 mm

2 springs for PE-contact

page 1.9.25



MVT

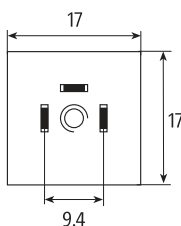

**Form CI, Industrial standard**

Pin spacing 9.4 mm

2 springs for PE-contact

page 1.9.25

# EMC SUPPRESSORS

## Suppressors for contactors



BC



A 16



A 110

Approvals:



### Circuit diagram

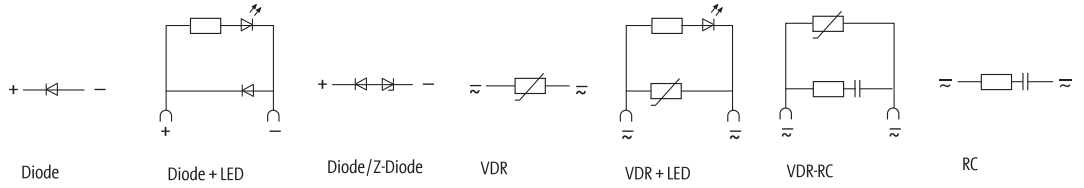

### Appropriate contactors

B 6, BC 6, VB 6, KC 6

A 9...A 16

A 26...A 110

### Ordering data

Ordering data		Art.-No.		Art.-No.		Art.-No.	
Voltage	Suppression	Approval		Approval		Approval	
24 ...240 V DC	Diode			UL	26440		
24 V DC	Diode + LED						
	Diode/Z-Diode						
24 V AC/DC	VDR	UL + CSA	26277	UL	26442		
	VDR + LED						
	RC			UL	21170		
48 V DC	Diode/Z-Diode						
48 V AC/DC	VDR	UL + CSA	26278				
	RC						
110 V AC/DC	VDR			UL	26444		
	VDR + LED						
	VDR-RC						
	RC			UL + CSA	21172	UL	21173
230 V AC/DC	VDR	UL + CSA	26079	UL	26446		
	VDR + LED						
	VDR-RC						
	VDR-RC + LED						
400 V AC/DC	RC			UL + CSA	21172	UL	21173
	VDR						
	RC						
415 V AC/DC	RC						

### Technical data

Damping factor	$\sim 1.5 \times U_N$
Temperature range	-20...+70 °C
Material	plastic, flame retardant (UL 94)
Connection wires	self-securing cable forks

### Dimension drawing

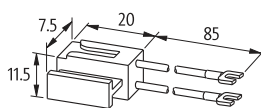

plug contact

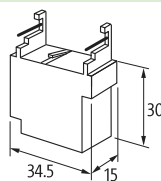

### Notes

EMC Suppressors

## Suppressors for contactors



M

CL



Approvals:



### Circuit diagram

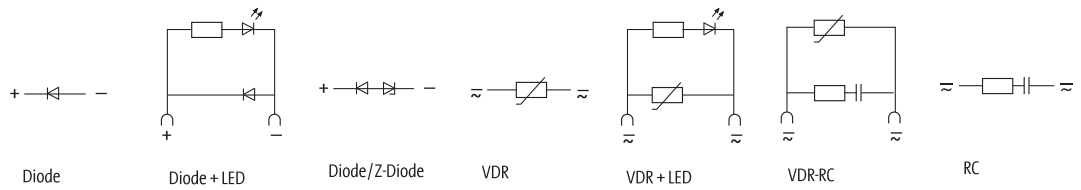

### Appropriate contactors

M	CL00, 01, 02, 25	CL03, 04, 45	CL05...10
---	------------------	--------------	-----------

### Ordering data

		Art.-No.	Art.-No.	Art.-No.	Art.-No.
Voltage	Suppression				
24 ...240 V DC	Diode	2000-68300-110 0000	2000-69100-110 0000	<sup>1)</sup> 2000-69200-110 0000	
24 V DC	Diode + LED				
	Diode/Z-Diode				
24 V AC/DC	VDR	2000-68300-440 0000	2000-69100-440 0000	2000-69200-440 0000	2000-69100-440 0000
	VDR + LED				
	RC	2000-68300-430 0000	2000-69100-430 0000	2000-69200-430 0000	2000-69101-430 0000
48 V DC	Diode/Z-Diode				
48 V AC/DC	VDR	2000-68300-440 0000	2000-69100-440 0000	2000-69200-440 0000	2000-69100-440 0000
	RC	2000-68300-430 0000	2000-69100-430 0000	2000-69200-430 0000	2000-69101-430 0000
110 V AC/DC	VDR		2000-69100-740 0000	2000-69200-740 0000	2000-69100-740 0000
	VDR + LED				
	VDR-RC				
	RC	2000-68300-132 0000	2000-69100-730 0000	2000-69200-730 0000	2000-69101-730 0000
230 V AC/DC	VDR		2000-69100-242 0000	2000-69200-242 0000	
	VDR + LED				
	VDR-RC				
	VDR-RC + LED				
	RC	2000-68300-132 0000	2000-69100-232 0000	2000-69200-232 0000	2000-69101-232 0000
400 V AC/DC	VDR		2000-69100-542 0000	2000-69200-542 0000	2000-69100-542 0000
	RC				
415 V AC/DC	RC				

### Technical data

Damping factor	~ 1.5 x U <sub>N</sub>
Temperature range	-20...+70 °C
Material	plastic, flame retardant (UL 94)
Connection wires	plug contact

### Dimension drawing

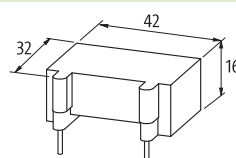
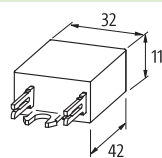

### Notes

<sup>1)</sup> Also for CL05...10 DC-coils.



# EMC SUPPRESSORS

## Suppressors for contactors



## X-Start



### Approvals:



### Circuit diagram

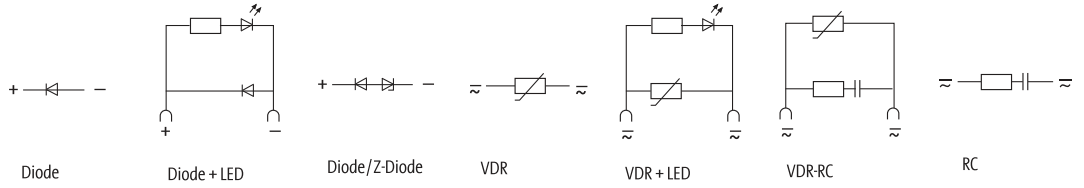

### Appropriate contactors

DIL M7...15 DIL MP20, DIL A	DIL M17...32	DIL M40...95
--------------------------------	--------------	--------------

### Ordering data

Voltage	Suppression	Approval	Art.-No.	Approval	Art.-No.	Approval	Art.-No.
24 ...240 V DC	Diode						
24 V DC	Diode + LED						
	Diode/Z-Diode						
24 V AC/DC	VDR						
	VDR + LED	CSA	26013	CSA	26015	CSA	26018
	RC						
48 V DC	Diode/Z-Diode						
48 V AC	VDR + LED	CSA	26013	CSA	26015	CSA	26018
	RC						
110 V AC/DC	VDR						
	VDR + LED	CSA	26014				
	VDR-RC						
	RC	CSA	20007	CSA	20008	CSA	20009
230 V AC/DC	VDR						
	VDR + LED	UL + CSA	26014				
	VDR-RC						
	VDR-RC + LED						
	RC	CSA	20007	CSA	20008	CSA	20009
400 V AC/DC	VDR						
	RC						

### Technical data

Damping factor	$\sim 1.5 \times U_N$
Temperature range	-20...+70 °C
Material	plastic, flame retardant (UL 94)
Connection wires	plug contact

### Dimension drawing

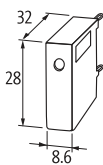

### Notes

LED indicator for 24 V DC without suppression available on request.

EMC Suppressors

# EMC SUPPRESSORS

Suppressors for contactors



DIL E



B DIL



K DIL

Approvals:



## Circuit diagram

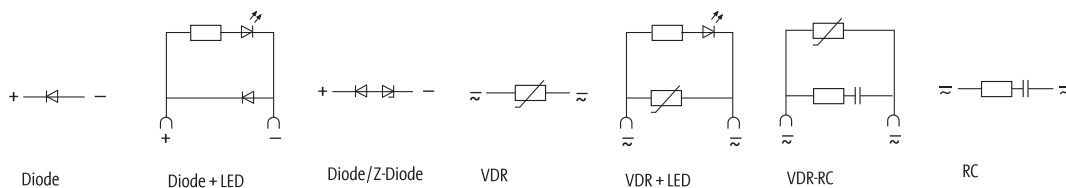

## Appropriate contactors

DIL E...	DIL E...C	DIL 3 - 4...M DIL 3 H, DIL 4 H	DIL 0 - 2...M DIL R...
----------	-----------	-----------------------------------	---------------------------

## Ordering data

Ordering data		Art.-No.		Art.-No.		Art.-No.		Art.-No.	
Voltage	Suppression	Approval	Approval	Approval	Approval	Approval	Approval	Approval	Approval
24 ...240 V DC	Diode							UL + CSA	26080
24 V DC	Diode + LED							UL + CSA	<b>26081</b>
	Diode/Z-Diode							UL + CSA	26170
24 V AC/DC	VDR	UL + CSA	26116			UL + CSA	26082	UL + CSA	26170
	VDR + LED							UL + CSA	21026
	RC							UL + CSA	21026
48 V DC	Diode/Z-Diode							UL	26171
48 V AC/DC	VDR							UL	26171
	RC							UL	26171
110 V AC/DC	VDR							UL + CSA	21028
	VDR + LED							UL + CSA	21028
	VDR-RC							UL + CSA	21028
	RC	UL + CSA	21054	UL + CSA	21056	UL + CSA	21073	UL + CSA	21028
230 V AC/DC	VDR	UL + CSA	26086	UL	26119	UL + CSA	26022	UL	26173
	VDR + LED							UL	26173
	VDR-RC							UL	26173
	VDR-RC + LED							UL	26173
	RC	CSA	21054	UL + CSA	21056			UL + CSA	21028
	RC					UL + CSA	21073	UL + CSA	21028
400 V AC/DC	VDR							UL + CSA	21028
	RC							UL + CSA	21028

## Technical data

Damping factor	$\sim 1.5 \times U_N$
Temperature range	-20...+70 °C
Material	plastic, flame retardant (UL 94)
Connection wires	self-securing cable forks      ferrule ends for spring contact      plug contact

## Dimension drawing

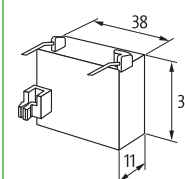
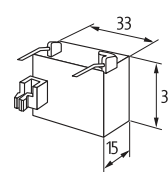
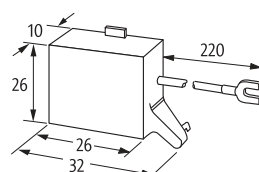

## Notes

EMC Suppressors

# EMC SUPPRESSORS

Suppressors for contactors

**OMRON**

J7KNA



J7KN



J7KN



## Circuit diagram

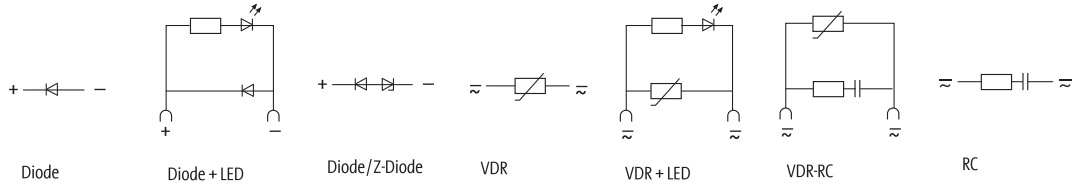

## Appropriate contactors

J7KNA

J7KN

J7KN

## Ordering data

		Art.-No.	Art.-No.	Art.-No.
Voltage	Suppression			Approval
24 ...240 V DC	Diode			
24 V DC	Diode + LED			
	Diode/Z-Diode			
24 V AC/DC	VDR			GOSTR / UL      26400
	VDR + LED			
	RC	2000-68800-230 0000	2000-69000-230 0000	
48 V DC	Diode/Z-Diode			
48 V AC	VDR			GOSTR / UL      26401
	RC			
110 V AC/DC	VDR			
	VDR + LED			
	VDR-RC			
	RC	2000-68800-730 0000	2000-69000-730 0000	
230 V AC/DC	VDR			GOSTR / UL      26403
	VDR + LED			
	VDR-RC			
	VDR-RC + LED			
	RC	2000-68800-232 0000	2000-69000-232 0000	
400 V AC/DC	VDR			GOSTR / UL      26404
	RC			

## Technical data

Damping factor	$\sim 1.5 \times U_N$
Temperature range	-20...+70 °C
Material	plastic, flame retardant (UL 94)
Connection wires	self-securing cable forks

## Dimension drawing

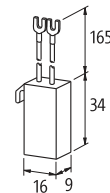
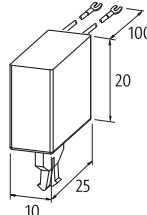
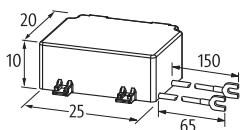

## Notes

Further types on request.

EMC Suppressors

# EMC SUPPRESSORS

## Suppressors for contactors



### I00-M



### I00-C



### Circuit diagram

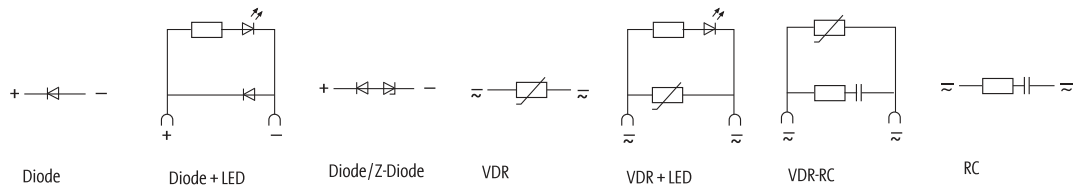

### Appropriate contactors

I00 M

I00-C09...C85

### Ordering data

### Art.-No.

### Art.-No.

Voltage	Suppression	Approval	Art.-No.	Approval	Art.-No.
24 ...240 V DC	Diode	UL + CSA / GOST-R	26360		2000-68200-110 0000
24 V DC	Diode + LED				
24 V AC/DC	Diode /Z-Diode				
	RC				2000-68200-430 0000
	VDR	UL + CSA / GOST-R	26375		2000-68200-440 0000
48V AC/DC	RC			UL + CSA	2000-68200-430 0000
	VDR				2000-68200-440 0000
110V AC/DC	VDR				2000-68200-740 0000
	VDR + LED				
	VDR-RC				
	RC				2000-68200-132 0000
230 V AC/DC	VDR	UL + CSA / GOST-R	26378	UL + CSA	2000-68200-242 0000
	VDR + LED				
	VDR-RC				
	VDR-RC + LED				
400V AC/DC	RC	UL + CSA / GOST-R	21143	UL + CSA	2000-68200-132 0000
	VDR				2000-68200-532 0000
	VDR				2000-68200-542 0000

### Technical data

Damping factor	~ 1.5 x U <sub>N</sub>
Temperature range	-20...+70 °C
Material	plastic, flame retardant (UL 94)
Connection wires	ferrule ends

### Dimension drawing

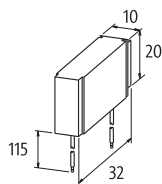

### plug contact

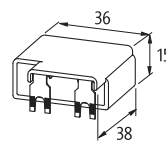

### Notes

# EMC SUPPRESSORS

## Suppressors for contactors



TeSys

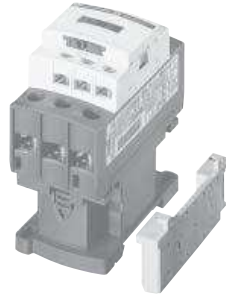

TeSys



TeSys



D



### Circuit diagram

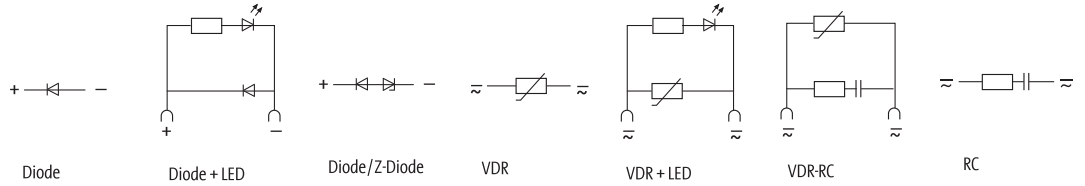

### Appropriate contactors

LC 1 D09...D38 LC 1 DT20, DT40, LC 2 D09...D38 AC-coil	LC 1 D09...D38 LC 1 DT20, DT40, LC 2 D09...D38 DC-coil	CA 2 DN, CA 3 DN serie „d“ LC 1 DT20, DT40, LC 2 D09...D38
--	--	---

Ordering data		Art.-No.	Art.-No.	Art.-No.	Art.-No.
Voltage	Suppression	Approval	Approval	Approval	Approval
24 ...240 V DC	Diode			UL 2000-69300-110 0000	GOST-R 26481
24 V DC	Z-Diode	GOST-R 26476		UL 2000-69300-520 0000	
24 V AC/DC	VDR		UL 2000-69400-440 0000	UL 2000-69300-440 0000	GOST-R 26487
	RC	GOST-R 21062	UL 2000-69400-430 0000	UL 2000-69300-430 0000	GOST-R 21070
30...250 V DC	Z-Diode			UL 2000-69300-122 0000	
48 V AC/DC	VDR		UL 2000-69400-440 0000	UL 2000-69300-440 0000	
	VDR + LED				
	RC		UL 2000-69400-430 0000	UL 2000-69300-430 0000	GOST-R 21070
110V AC/DC	VDR		UL 2000-69400-740 0000	UL 2000-69300-740 0000	
	VDR + LED				
230V AC/DC	RC	GOST-R 21063	UL 2000-69400-730 0000	UL 2000-69300-730 0000	GOST-R 21071
	VDR	GOST-R 26478	UL 2000-69400-242 0000		GOST-R 26491
	VDR + LED				
	VDR			UL 2000-69300-242 0000	
	VDR-RC + LED				
400V AC/DC	RC	GOST-R 21063	UL 2000-69400-232 0000	UL 2000-69300-232 0000	GOST-R 21060
	RC + LED				
	VDR		UL 2000-69400-542 0000		
RC		UL 2000-69400-532 0000			

### Technical data

Damping factor	$\sim 1.5 \times U_N$
Temperature range	-20...+70 °C
Material	plastic, flame retardant (UL 94)

Connection wires	plug contact	self-securing cable forks	self-securing cable forks	plug contact
------------------	--------------	---------------------------	---------------------------	--------------

### Dimension drawing

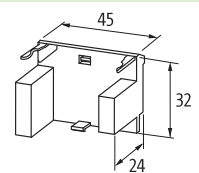
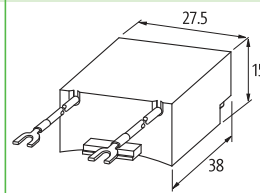
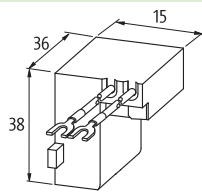
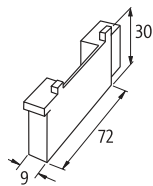

### Notes

EMC Suppressors

# EMC SUPPRESSORS

Suppressors for contactors

S00

S0

**SIEMENS**



Approvals:



**Circuit diagram**

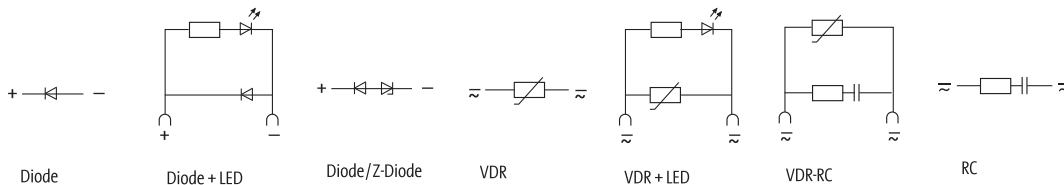

**Appropriate contactors**

3 RH 1/11, 3 RT 1/3 RH 1  
3 RT 1/10.15...10.17

3 RT 10.24/25/26

**Ordering data**

**Art.-No.**

**Art.-No.**

Voltage	Suppression	Approval	Art.-No.	Approval	Art.-No.
24 ...240 V DC	Diode	UL + CSA	<b>26500</b>		
24 V DC	Diode + LED	UL + CSA	26501		
24 V AC/DC	Diode /Z-Diode	UL + CSA	<b>26502</b>	UL + CSA	<sup>1)</sup> 26528
	Diode/Z-Diode			UL + CSA	26520
	VDR	UL + CSA	<b>26503</b>	UL + CSA	26524
	VDR + LED	UL + CSA	<b>26504</b>		
	RC	UL + CSA	21200	UL + CSA	21210
110 V AC/DC	VDR				
	VDR + LED				
	VDR-RC				
	RC	UL + CSA	<b>21201</b>		
230 V AC/DC	VDR	UL + CSA	26507	UL + CSA	26526
	VDR + LED	UL + CSA	26508		
	VDR-RC				
	VDR-RC + LED				
	RC	UL + CSA	<b>21202</b>	UL + CSA	21212
400 V AC/DC	VDR				

**Technical data**

Damping factor	~ 1.5 x U <sub>N</sub>
Temperature range	-20...+70 °C
Material	plastic, flame retardant (UL 94)
Connection wires	plug contact

**Dimension drawing**

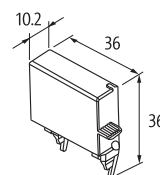
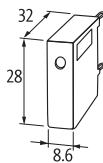

**Notes**

<sup>1)</sup> Mounts on the underside of the contactor

# EMC SUPPRESSORS

Suppressors for contactors

**SIEMENS**

Approvals:



S2



S3



S6 - S12



**Circuit diagram**

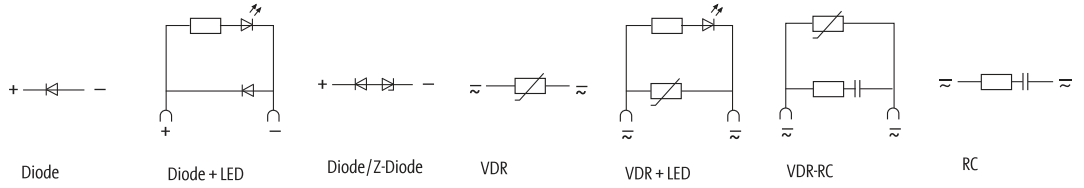

**Appropriate contactors**

3 RT 1.3/1.4

3 RT 1.5/6/7

**Ordering data**

Voltage	Suppression	Approval	Art.-No.	Approval	Art.-No.	Art.-No.
24 V DC	Diode + LED					
	Diode + Z-Diode + LED					
	Diode/Z-Diode			UL + CSA	26521	
24 V AC/DC	VDR			UL + CSA	26524	
	VDR + LED					
48 V DC	RC	UL + CSA	21215			21220
	Diode/Z-Diode					
48 V AC/DC	VDR					
	RC					21220
110 V AC/DC	VDR					
	VDR + LED					
	VDR-RC					
	RC					21221
230 V AC/DC	VDR			UL + CSA	26526	
	VDR + LED					
	VDR-RC					
	RC	UL + CSA	21217			21222
400 V AC/DC	RC					
	VDR					

**Technical data**

Damping factor	~ 1.5 x U <sub>N</sub>
Temperature range	-20...+70 °C
Material	plastic, flame retardant (UL 94)
Connection wires	plug contact

**Dimension drawing**

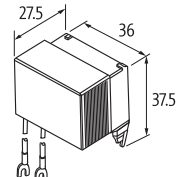
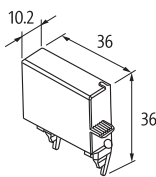

**Notes**

EMC Suppressors

# EMC SUPPRESSORS

Suppressors for contactors

## SIEMENS

S0 4



S0 1



3 TF/L-3 TF



Approvals:



### Circuit diagram

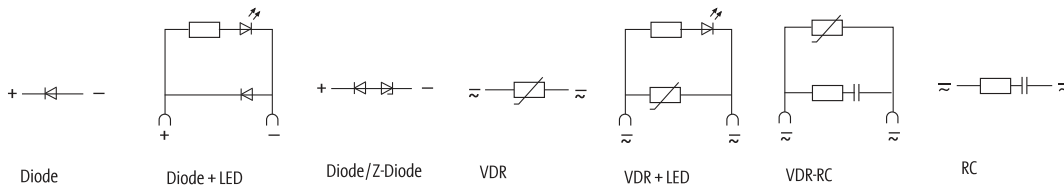

### Appropriate contactors

3 TH 3/4 3 TF 30...35, 3 TF 40...45	3 TH 3/4/8, 3 TF 30...45 3 TB 40...3 TB 44	3 TH 2, 3 TF 2 3 TH 20, 3 TF 20
--	---	------------------------------------

### Ordering data

Ordering data		Art.-No.	Art.-No.	Art.-No.
Voltage	Suppression	Approval	Approval	Approval
24 ...240 V DC	Diode	26588	UL + CSA	26283
24 V DC	Diode + LED			UL
	Diode/Z-Diode		UL + CSA	26051
24 V AC/DC	VDR	CSA	UL + CSA	26315
	VDR + LED			UL + CSA
	RC		UL + CSA	22050
48 V DC	Diode/Z-Diode			UL
48 V AC/DC	VDR	CSA		UL
	RC		UL + CSA	22051
110 V AC/DC	VDR			
	VDR + LED			
	VDR-RC			
	RC		UL + CSA	22051
230 V AC/DC	VDR	CSA	UL + CSA	26317
	VDR + LED			UL
	VDR-RC			UL
	RC		UL + CSA	22052
	RC		UL + CSA	22054
400 V AC/DC	VDR	CSA		
	RC		UL + CSA	22054

### Technical data

Damping factor	~ 1.5 x U <sub>N</sub>
Temperature range	-20...+70 °C
Material	plastic, flame retardant (UL 94)
Connection wires	self-securing cable forks

### Dimension drawing

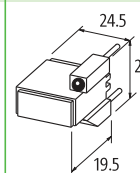
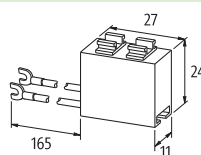
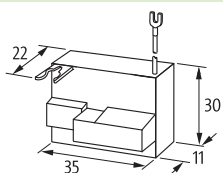

### Notes



# EMC SUPPRESSORS

## Suppressors

– universal

A0



AD



CF



Approvals:



### Circuit diagram

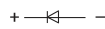

Diode

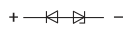

Diode/Z-Diode



VDR

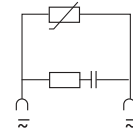

VDR-RC

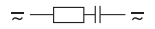

RC

### Appropriate contactors

Universal

Universal

Universal

### Ordering data

Ordering data		Art.-No.		Art.-No.		Art.-No.		sugg. coil valves		
Voltage	Suppression	Approval		Approval		Approval		AO	AD	CF
Max. 240 V DC	Diode	CSA	26001					15 W		
24 V DC	Z-Diode	CSA	26120	CSA	26073			25 W	75 W	
24 V AC/DC	VDR	UL + CSA	26180	CSA	26720			50 VA/W	200 VA/W	
	RC					CSA	20680			15 VA
48 V AC/DC	VDR	UL + CSA	26181	CSA	26721			70 VA/W	200 VA/W	
	RC	UL + CSA	20001	UL + CSA	20013			10 VA	15 VA	
110 V AC/DC	VDR	UL + CSA	26182	CSA	26722			100 VA/W	200 VA/W	
	VDR-RC									
230 V AC/DC	RC									
	VDR	UL + CSA	26183	CSA	26723			200 VA/W	200 VA/W	
400 V AC/DC	VDR	UL + CSA	<sup>1)</sup> 26184					200 VA/W		
	RC			CSA	20014	CSA	20682		25 VA	15 VA
	RC	UL + CSA	<b>20002</b>	UL + CSA	20010	CSA	20683	20 VA	75 VA	20 VA
	RC			UL + CSA	20011	CSA	<sup>2)</sup> 20687		100 VA	50 VA
400 V AC/DC	VDR			CSA	26724				200 VA/W	
	RC	UL + CSA	20004	UL + CSA	20012	CSA	20688	15 VA	20 VA	10 VA
	RC									

### Technical data

Damping factor	approx. 1.5
Temperature range	-20...+70 °C
Material	plastic, flame retardant (UL 94)
Connection wires	self-securing cable forks

### Dimension drawing

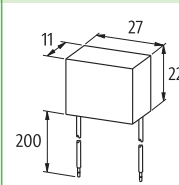
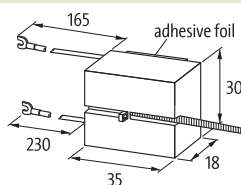
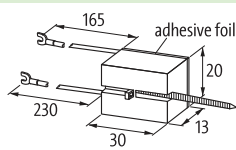

Form 1

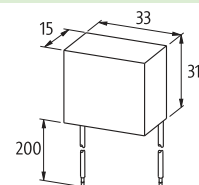

<sup>2)</sup> Form 2

### Notes

<sup>1)</sup> Up to 300 V AC/DC

# EMC SUPPRESSORS

## Suppressors

– universal

H

RC-BUG 2

BU + UB



Approvals:



### Circuit diagram

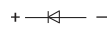

Diode

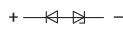

Diode/Z-Diode

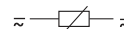

VDR

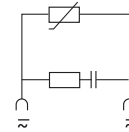

VDR-RC

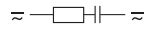

RC

### Appropriate contactors

Universal

Universal

Universal

### Ordering data

Ordering data		Art.-No.		Art.-No.		Art.-No.			sugg. coil valves		
Voltage	Suppression	Approval		Approval		Approval			H	RC-BUG 2	BU + UB
24 ... 240 V DC	Diode	CSA	26097			CSA	26020		1000V/1A		1000V/1A
24 V DC	Z-Diode	CSA	26095			CSA	26130		25 W		25 W
24 V AC/DC	VDR	UL + CSA	26090			UL + CSA	26150		50 VA/W		50 VA/W
	RC			CSA	26612					146 VA	
48 V AC/DC	VDR										
	RC	CSA	20100	CSA	26612				15 VA	146 VA	
110 V AC/DC	VDR	UL + CSA	26092	CSA	26618				100 VA/W	100 VA/W	
	VDR-RC										
	RC			CSA	26613					146 VA	
230 V AC/DC	VDR	UL + CSA	26093	CSA	26603				200 VA/W	10 VA/W	
	VDR	UL + CSA	26094	CSA	26619	UL + CSA	26155		200 VA/W	100 VA/W	200 VA/W
	RC	CSA	20101	CSA	26614	CSA	20031		15 VA	146 VA	20 VA
	RC	CSA	20102			CSA	20033		25 VA		25 VA
	RC	CSA	20103			CSA	<sup>1)</sup> 20034		75 VA		25 VA
400 V AC/DC	VDR			CSA	26604					10 VA/W	
	RC			CSA	26615	CSA	20032			146 VA	15 VA
	RC			CSA	<sup>2)</sup> 26616					146 VA	

### Technical data

Damping factor	approx. 1.5	
Temperature range	-20...+70 °C	
Material	plastic, flame retardant ( UL 94)	
Mounting method	DIN-rail mounting (EN 60715)	with adapter ASA Art.-No. 20900, DIN-rail mounting (EN 60715)
Connection wires	self-securing cable forks	

### Dimension drawing

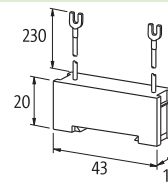
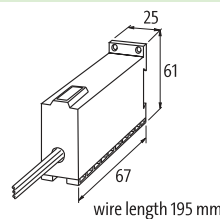
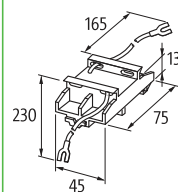

### Notes

- <sup>1)</sup> Without adapter, can be directly snapped onto DIN-rail, ASA adapter Art.-No. 20900 included in delivery.
- <sup>2)</sup> Up to 600 V AC/DC

# EMC SUPPRESSORS

## Suppressors for motors

### Mounting methods:

- on the motor terminal box
- inside the motor terminal box
- inside the distribution box
- on 35 mm DIN-rail acc. to EN 60715

### Approvals:



### RC 3 U

With M16 x 1.5 screw



### RC 3 BU



### RC 3 BUG



### Circuit diagram

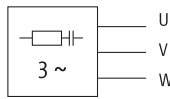

RC

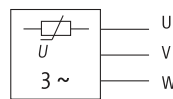

VDR

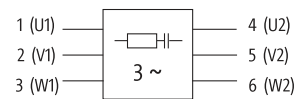

RC-(1) per phase

### Ordering data

Ordering data		Art.-No.	Art.-No.	Art.-No.
3 x 400 V AC	Motor rating	Suppression/approval	Suppression/approval	Suppression/approval
	4 kW	RC	RC/UL	RC
	4 kW			VDR
	4 kW		VDR/UL	RC
	7.5 kW		VDR/UL	RC
	10 kW	RC	VDR/UL	RC
	10 kW	RC-(1) per phase		
3 x 575 V AC	4 kW		RC/UL	
	7.5 kW	RC/UL		RC
	20 kW			VDR
	45 kW			RC-(1) per phase
3 x 690 V AC	4 kW		RC/UL	RC
	7.5 kW			RC
	20 kW			VDR

### Technical data

Frequency	for RC: 50/60 Hz; for VDR: 10...400 Hz		
Material	plastic, flame retardant (UL 94)		
Potting compound	2-component epoxy		
Temperature range	-20...+60 °C		
Connection method	approx. 500 mm PVC cable 3 x 0.75 mm <sup>2</sup> or 6 x 0.75 mm <sup>2</sup>	approx. 200 mm single core 0.5 mm <sup>2</sup> with self-securing M4 cable forks M4	approx. 500 mm single core 1 mm <sup>2</sup>

### Dimension drawing

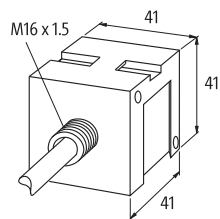

For DIN-rail mounting use  
2 x Art.-No. 20900 adapter feet

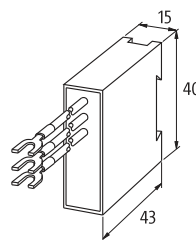

For DIN-rail mounting use  
1 x Art.-No. 20900 adapter feet

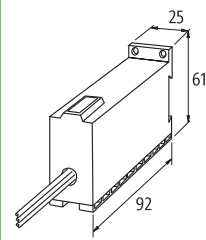

For DIN-rail mounting use  
2 x Art.-No. 20900 adapter feet

### Notes

Do not use RC motor suppressors on variable frequency drives.

<sup>1)</sup> 1 x Art.-No. 23103 required per phase.

## EMC SUPPRESSORS

### Suppressors for motors

#### Mounting methods:

- with M16 x 1.5 and M20 x 1.5
- on the motor terminal box with plug connectors

#### Approvals:



#### RC 3 R

With M16 x 1.5 screw



#### RC 3 R

With M16 x 1.5 screw

#### RC 3 RG

With M20 x 1.5 screw



#### Circuit diagram

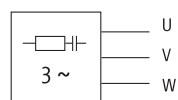

RC

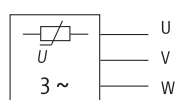

VDR

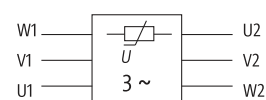

VDR-(1) per phase

Ordering data		Art.-No.	Art.-No.	Art.-No.
Voltage	Motor rating	Suppression/approval	Suppression/approval	Suppression/approval
3 x 400 V AC	4 kW	VDR/UL	<b>23170</b>	VDR/UL
	4 kW			
	4 kW			
	7.5 kW	VDR	<b>23171</b>	
	10 kW			VDR
	10 kW			VDR-(1) per phase
3 x 575 V AC	20 kW			VDR
	4 kW	VDR/UL	23172	RC/UL
	7.5 kW	VDR/UL	23173	
	10 kW			VDR/UL
	20 kW			VDR/UL
3 x 690 V AC	20 kW			VDR-(1) per phase
	7.5 kW	VDR	<sup>1)</sup> 23174	
	20 kW			
	20 kW			VDR

#### Technical data

Frequency	for RC: 50/60 Hz; for VDR: 10...400 Hz		
Material	plastic, flame retardant (UL 94)		
Potting compound	2-component epoxy		
Temperature range	-20...+60 °C		
Connection method	approx. 100 mm single core 0.5 mm <sup>2</sup>		approx. 150 mm single core 1 mm <sup>2</sup>
Ring terminals	isolated M6	isolated M4	isolated M6

#### Dimension drawing

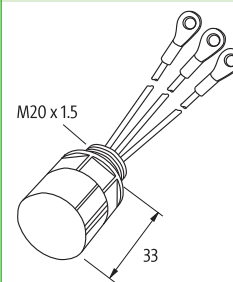
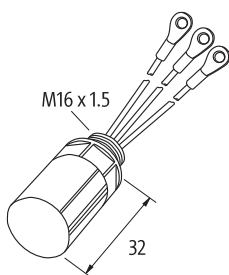

#### Notes

Do not use RC motor suppressors on variable frequency drives.

<sup>1)</sup> Wire diameter 1.5 mm<sup>2</sup>.

# EMC SUPPRESSORS

## Suppressors for motors

### Mounting methods:

- on the motor terminal box with plug connectors

### Approvals:



### RC 3 ST

Connector with cable and integrated motor suppression  
Cable outlet in the back



### RC 3 ST

Connector with cable and integrated motor suppression  
Cable outlet (right angle)



### Circuit diagram

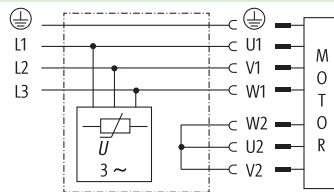

Varistor-suppression (star)

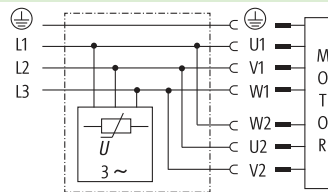

Varistor-suppression (delta)

### Ordering data

Voltage	Motor rating	Cable length	Suppression	Art.-No.	Suppression	Art.-No.
max.	5.5 kW	5 m	VDR/star	236139	VDR/star	236148
3 x 575 V AC	5.5 kW	6 m	VDR/star	236140		
	5.5 kW	8 m	VDR/star	236141		
	5.5 kW	10 m	VDR/star	236142	VDR/star	236149
	5.5 kW	6 m	VDR/delta	236143		

### Technical data

Frequency	10..400 Hz	
Plug connector	females, 10-pole + PE	
Housing	aluminium pressure diecasting	
Temperature range	-20...+60 °C	
Connection method	PUR cable black, 4 x 1.5 mm <sup>2</sup> ; numbered wires, halogen free	PUR cable black, 4 x 1.5 mm <sup>2</sup> ; numbered wires, DESINA <sup>®</sup> compliant

### Dimension drawing

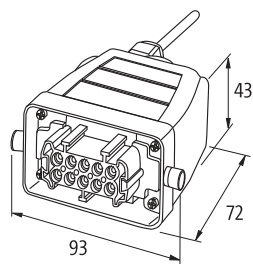

(without compression gland)

### Notes

# EMC SUPPRESSORS

## Suppressors for motors

### Mounting methods:

- on 35 mm DIN-rail acc. to EN 60715
- bolted together, stacked
- DIN-rail mounting under the control gear

### Approvals:



### HRC 3



### HRC 3 K



### RC 3 BUR

Connects onto Siemens SIRIUS contactors  
3 RT 10



### Circuit diagram

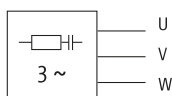

RC

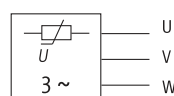

VDR

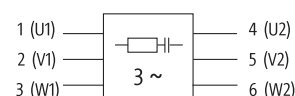

RC(1) per phase

Ordering data		Art.-No.	Art.-No.	Art.-No.
Voltage	Motor rating	Suppression/approval	Suppression/approval	Suppression/approval
3 x 400 V AC	4 kW	RC/UL	<sup>2)</sup> 23000	RC
	4 kW	RC/UL	<b>23004</b>	RC
	4 kW	RC/UL	<sup>1)</sup> 233463	
	5.5 kW			RC/UL
	7.5 kW			<b>236082</b>
	10 kW	RC/UL	<b>23002</b>	RC
	20 kW	RC(1) per phase/UL	23009	23003
3 x 575 V AC	20 kW	VDR/UL	23015	
	5.5 kW			RC/UL
	7.5 kW	RC/UL	<b>23006</b>	RC
	7.5 kW	RC/UL	<sup>1)</sup> 230563	23007
	10 kW	VDR/UL	23016	
3 x 690 V AC	20 kW			RC
	10 kW	RC	23017	23018

### Technical data

Frequency	for RC: 50...60 Hz, for VDR: 10...400 Hz		
Material	plastic, flame retardant (UL 94)		
Potting compound	2-component epoxy		
Temperature range	-20...+60 °C		
Connection method	approx. 250 mm s. core (Art.-No. 23000: 300 mm)	3-pole terminal	wire (solid core)
	0.5 mm <sup>2</sup> (Art.-No. 23000: 1.5 mm <sup>2</sup> )	2 x 0.75...2.5 mm <sup>2</sup>	1.5 mm <sup>2</sup>
	with self-securing M4 cable forks	M4	–

### Dimension drawing

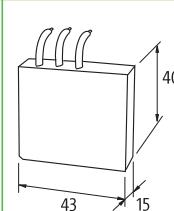
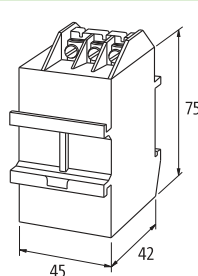
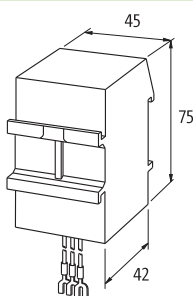

### Notes

Do not use RC motor suppressors on variable frequency drives.

<sup>1)</sup> With ferrule ends. <sup>2)</sup> Max. nominal voltage 3 x 500 V AC +10 %.

# EMC SUPPRESSORS

## Suppressors for motors

### Mounting methods:

- DIN-rail mounting under the control gear
- fixes onto contactors
- available with integrated coil suppression

### Approvals:



## HRC 3 AS



## RC 3 RT

Connects onto Siemens SIRIUS contactors 3 RT 10



### Circuit diagram

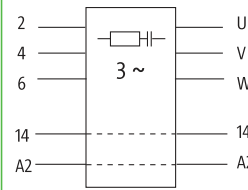
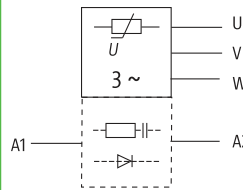
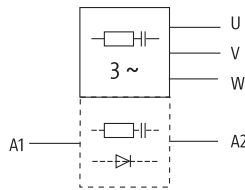

### Appropriate contactors

Motor contactors up to 5.5 kW from Siemens, Moeller, Sprecher + Schuh etc.

Siemens 3 RT 10

### Ordering data

		Art.-No.		Art.-No.		Art.-No.	
Voltage	Motor rating	Suppression motor + coil		Suppression motor + coil		Suppression/approval	
3 x 400 V AC	5.5 kW	RC	23160	VDR	23163	RC/UL + CSA	23180
	5.5 kW	RC + Diode	23151	VDR + Diode	23155		
3 x 575 V AC	5.5 kW	RC	23161	VDR	23164	RC/UL + CSA	23181
	5.5 kW	RC + Diode	23153	VDR + Diode	23157		

### Technical data

Suppression coil	for RC: 230 V AC/20 VA, for RC + Diode: 24...230 V DC/36 W
Frequency	for RC: 50...60 Hz, for VDR: 10...400 Hz
Material	plastic, flame retardant (UL 94)
Temperature range	-20...+60 °C
Connection method	ferrules, load side securely fixed

fits directly into SIRIUS contactors, size 00

### Dimension drawing

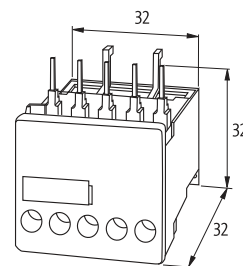
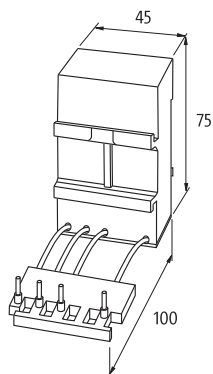

### Notes

Do not use RC motor suppressors on variable frequency drives.

# EMC SUPPRESSORS

## Suppressors for valves

- with LED
- with suppression

### VBS

Form A  
Pin spacing 18 mm  
EN 175301-803 (ISO 4400)



### LBS

Form BI Industrial standard  
Pin spacing 11 mm



### Circuit diagram

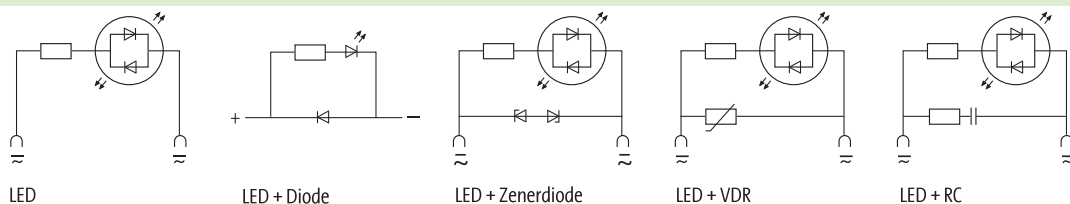

Ordering data		Art.-No.	Art.-No.	Switch off- delay time [ms]	Switch off- voltage peak [V]	Valve hold-on rating [W/VA]
Voltage	Suppression					
24 V DC	LED + Diode	<sup>1)</sup> 3124021	3124221	200	1	50
	LED	<sup>1)</sup> 3124015	3124215	–	–	50
	LED + Z-Diode	<sup>1)</sup> 3124033	3124233	20	55	100
	LED + VDR	<sup>1)</sup> 3124048	3124248	15	45	50
	LED + RC	3124068		20	105	10
48 V AC/DC	LED + RC		3124269	20	70	20
	LED	<sup>1)</sup> 3124017		–	–	50
110 V AC/DC	LED + VDR	<sup>1)</sup> 3124052		10	75	100
	LED + RC	<sup>2)</sup> 3124071		20	90	30
	LED	3124018		–	–	50
230 V AC/DC	LED + VDR	3124046		10	235	100
	LED + RC	3124070		20	250	10
	LED + RC	<sup>2)</sup> 3124072		20	250	25
	LED	3124016	3124216	–	–	50
	LED + VDR	3124049	3124249	15	360	100
	LED + RC	3124063	3124263	20	300	10
	LED + RC	<sup>2)</sup> 3124064		20	300	25

### Technical data

Supply indicator	LED yellow
Contact material	silvered bronze
Protection	IP65 when fully mounted
Material	polyamide black, flame retardant, temperature resistant up to 130 °C
Temperature range	-20...+60 °C

### Dimension drawing

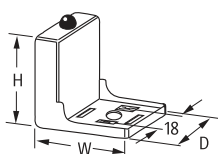

Housing H x W x D: 37 x 45 x 30 mm  
<sup>1)</sup> Housing H x W x D: 37 x 39 x 30 mm  
<sup>2)</sup> Housing H x W x D: 37 x 53 x 33 mm  
 0° and 180° version on request

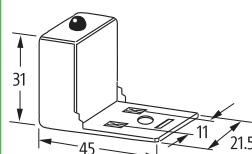

Note PIN arrangement (PE at cable outlet of connector)  
 180° version on request

### Notes

Do not use plug gasket when fitting adapter. Other LED colors on request.  
 For double valves the VA 2 series is suitable (please inquire). <sup>3)</sup> Polarity dependent



# EMC SUPPRESSORS

## Suppressors for valves

- with LED
- with suppression

### DAB/PBS

Form B/BI  
Pin spacing 10/11 mm  
EN 175301-803 (ISO 6952)



### MVK/MVT

Form C/CI  
Pin spacing 8/9.4 mm  
EN 175301-803 (ISO 6952)



### Circuit diagram

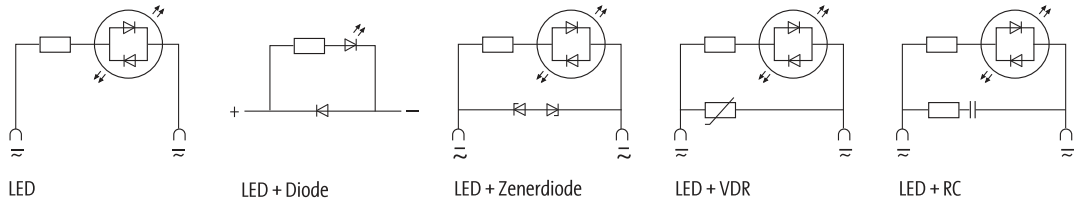

Ordering data		Art.-No.	Art.-No.	Art.-No.	Art.-No.	Switch off-delay time	Switch off-voltage peak	Valve hold-on rating
Voltage	Suppression	Form B	Form BI	Form C	Form CI	[ms]	[V]	[W/VA]
24 V DC 24 V AC/DC	LED + Diode	3124871	3124121			200	1	50
	LED	3124875	3124115	3124811	3124815	-	-	50
	LED + Z-Diode	3124873	3124133	3124833	3124832	20	55	100
	LED + VDR		3124148			15	45	50
	LED + RC		3124169			20	70	20
110 V AC/DC	LED + VDR		3124146			10	235	100
	LED + RC		3124170			20	250	10
230 V AC/DC	LED		3124116			-	-	50
	LED + VDR		3124149			15	360	100
	LED + RC		3124163			20	300	10

### Technical data

Supply indicator	LED yellow
Contact material	silvered bronze
Protection	IP65 when fully mounted
Material	polyamide black, flame retardant, temperature resistant up to 130 °C
Temperature range	-20...+60 °C

### Dimension drawing

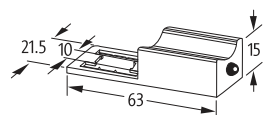

Suitable for 0° and 180° installation

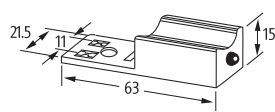

Note PIN arrangement  
(PE at cable outlet of connector)  
180° version on request

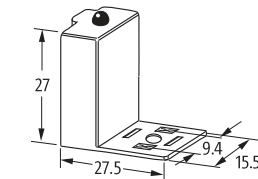
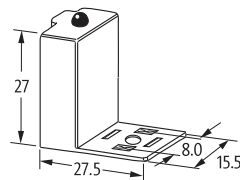

0° and 180° version on request

### Notes

Do not use plug gasket when fitting adapter. Other LED colors on request.  
Right-angle housing version with 10 mm pin spacing (DAR/DARU), on request. <sup>1)</sup>Polarity dependent

EMC Suppressors