

# Solenoid valves VZWD, directly actuated



Festo core product range  
Covers 80% of your automation tasks

Worldwide:  
Superb:  
Easy:

Always in stock  
Festo quality at an attractive price  
Reduces procurement and storing complexity



Generally ready for shipping ex works in 24 hours  
Held in stock in 13 service centres worldwide  
More than 2200 product



Generally ready for shipping ex works in 5 days  
Assembled for you in 4 service centres worldwide  
Up to 6 x 10<sup>12</sup> variants per product series

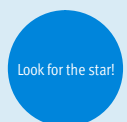

# Solenoid valves VZWD, directly actuated

Key features and overview

FESTO

## General



Directly actuated solenoid valves VZWD are mainly intended for applications with high pressure ranges and low flow rates. This type of valve switches the sealing

element directly via the solenoid system. The seal generally has to lift away from the seat against the effective operating pressure using just the drive. A closing spring

keeps the valve closed assisted by the pressure of the medium. The function is dependent on the seat size, the effective operating

pressure and the magnetic force. The differentiation from force pilot operated solenoid valves (VZWF) lies in the flow rate.

## General

-  - Connecting thread  
G 1/4, G 1/8
-  - Flow rate Kv  
0.06 ... 0.4 m<sup>3</sup>/h

## Areas of application

- Use in vacuum technology
- Venting gas and tank systems
- Safety shut-offs for burner controllers

## Design

- Design insensitive to slight contamination of the media

## Advantages

- Valves respond from 0 bar up to the max. operating pressure
- Excellent tightness

-  - Note

The valves are suitable for vacuum with Pabs > 100 mbar. Please ensure the direction of flow corresponds to the direction of the arrow.

# Solenoid valves VZWD, directly actuated

Key features and overview

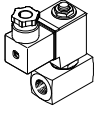
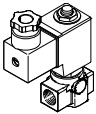
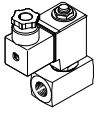
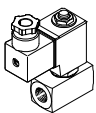
Version	Type	Process valve connection	Nominal size (DN)	Medium pressure <sup>1)</sup> [bar]	→ Page/Internet
<b>Brass housing</b>					
	VZWD-L-...	G 1/4	1	0 ... 50	5
			1.5	0 ... 30	
			2	0 ... 15	
			2.5	0 ... 8	
		G 1/8	1	0 ... 50	5
			1.5	0 ... 30	
			2	0 ... 15	
<b>Brass housing</b>					
	VZWD-L-...	G 1/4	1	0 ... 90	9
			1.5	0 ... 85	
			2	0 ... 40	
			2.5	0 ... 22	
			3	0 ... 15	
			4	0 ... 8	
			5	0 ... 5	
			6	0 ... 4	
		G 1/8	1	0 ... 90	9
			1.5	0 ... 85	
			2	0 ... 40	
			2.5	0 ... 22	
			3	0 ... 15	
			4	0 ... 8	
<b>Stainless steel housing</b>					
	VZWD-L-...-R1	G 1/4	1	0 ... 90	14
			1.5	0 ... 85	
			2	0 ... 40	
			2.5	0 ... 22	
			3	0 ... 15	
			4	0 ... 8	
			5	0 ... 5	
			6	0 ... 4	
	VZWD-L-...-R1	G 1/8	1	0 ... 90	14
			1.5	0 ... 85	
			2	0 ... 40	
			2.5	0 ... 22	
			3	0 ... 15	
			4	0 ... 8	
			5	0 ... 5	
			6	0 ... 4	

1) The valves are suitable for vacuum with Pabs > 100 mbar. Please ensure the direction of flow corresponds to the direction of the arrow.

# Solenoid valves VZWD, directly actuated

Type codes

VZWD - L - M22C - M - G18 - 15 - V - 2AP4 - 40 - R1

### Type

VZWD	Solenoid valve, directly actuated
------	-----------------------------------

### Type of directional control valve

L	In-line valve
---	---------------

### Valve function

M22C	2/2-way valve, normally closed, mechanical reset
------	--

### Reset method

M	Mechanical spring
---	-------------------

### Process valve connection

G18	Thread G 1/8
G14	Thread G 1/4

### Nominal size

10	1.0 mm
15	1.5 mm
20	2.0 mm
25	2.5 mm
30	3.0 mm
40	4.0 mm
50	5.0 mm
60	6.0 mm

### Sealing material

V	FPM
---	-----

### Nominal operating voltage

1	24 V DC
2A	110 V AC/50-60 Hz
3A	230 V AC/50-60 Hz

### Electrical connection

P4	Plug socket, 3-pin
----	--------------------

### Medium pressure

4	Max. 4 bar
5	Max. 5 bar
8	Max. 8 bar
15	Max. 15 bar
22	Max. 22 bar
30	Max. 30 bar
40	Max. 40 bar
50	Max. 50 bar
85	Max. 85 bar
90	Max. 90 bar

### Corrosion protection

-	Brass
R1	Stainless steel

# Solenoid valves VZWD, directly actuated

Technical data – Brass housing, nominal pressure PN 50

Function

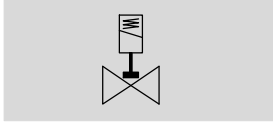

-  - Flow rate Kv  
0.06 ... 0.16 m<sup>3</sup>/h

-  - Connecting thread  
G 1/4, G 1/8



General technical data		1.0	1.5	2.0	2.5
Nominal size (DN)		1.0	1.5	2.0	2.5
Valve function		2/2-way, single solenoid, closed			
Design		Directly actuated poppet valve			
Type of mounting		In-line installation			
Actuation type		Electric			
Reset method		Mechanical spring			
Direction of flow		Non-reversible			
Type of control		Direct			
Manual override		None			
Mounting position		Any			
Sealing principle		Soft			
Max. viscosity	[mm <sup>2</sup> /s]	22			
Protection class		IP65			

Operating and environmental conditions		1.0	1.5	2.0	2.5
Nominal size (DN)		1.0	1.5	2.0	2.5
Standard nominal flow rate	[l/min]	60	95	140	170
Flow rate Kv	[m <sup>3</sup> /h]	0.06	0.09	0.13	0.16
Process valve nominal pressure (PN)		50			
Medium		Compressed air in accordance with ISO 8573-1:2010 [7:4:4]			
		Inert gases			
		Mineral oil			
		Neutral liquids			
		Water			
		Further media upon request			
Pressure differential	[bar]	0			
Ambient temperature	[°C]	-10 ... +35 °C			
Temperature of medium	[°C]	-10 ... +80 °C			
Leak rate to EN 12266-1		A			
Corrosion resistance class CRC <sup>1)</sup>		1			

1) Corrosion resistance class CRC 1 to Festo standard FN 940070  
Low corrosion stress. For dry indoor applications or transport and storage protection. Also applies to parts behind covers, in the non-visible interior area, and parts which are covered in the application (e.g. drive trunnions).

## Solenoid valves VZWD, directly actuated

FESTO

Technical data – Brass housing, nominal pressure PN 50

Electrical data			
Operating voltage		24 V DC	110 V AC 230 V AC
Electrical connection	Plug to EN 175301-803 type A, square design		
CE marking		–	73/23/EEC 73/23/EEC
Insulation class		H	F F
Duty cycle	[%]	100	
Permissible voltage fluctuations	[%]	±10	
Switching time on	[ms]	25	
Switching time off	[ms]	10	
Coil characteristics			
Direct current DC	[V]	24	– –
Alternating current AC	[V]	–	110 230
Power consumption	[W]	6.8	– –
Switching power	[VA]	–	10.5 10.5
Holding power	[VA]	–	8 7.6
	[Hz]	–	50, 60 50, 60

Materials		
Solenoid valves		Material number
Housing	High-alloy stainless steel	1.4305
	Brass	CW614N
Seals	FPM	
Note on materials	Contains PWIS (paint-wetting impairment substances)	
	RoHS-compliant	

# Solenoid valves VZWD, directly actuated

Technical data – Brass housing, nominal pressure PN 50

## Dimensions

Download CAD data → [www.festo.com](http://www.festo.com)

Milled brass housing

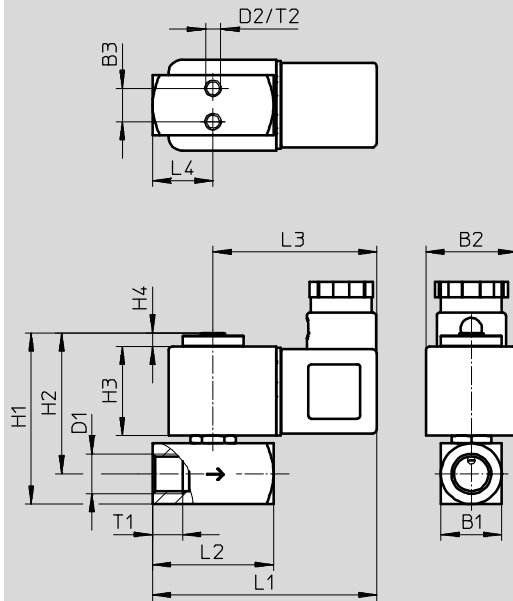

Type	B1	B2	B3	D1	D2	H1	H2	H3	H4	L1	L2	L3	L4	L5	T1	T2
VZWD-...-G1/8-10-...-50	15	30	8	G 1/8	M3	52	44	30	5	70	32	54	16	-	8	4.5
VZWD-...-G1/8-15-...-30																
VZWD-...-G1/8-20-...-15																
VZWD-...-G1/4-10-...-50	20	30	11	G 1/4	M5	57	47	30	5	74	40	54	20	-	10	5.5
VZWD-...-G1/4-15-...-30																
VZWD-...-G1/4-20-...-15																
VZWD-...-G1/4-25-...-8																

# Solenoid valves VZWD, directly actuated

Technical data – Brass housing, nominal pressure PN 50

FESTO

## ★ Core product range

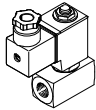
Ordering data							
	Process valve connection	Nominal size DN	Medium pressure <sup>1)</sup> [bar]	Product weight [g]	Operating voltage	Brass housing	
						Part No.	Type
	G 1/8	1	0 ... 50	300	24 V DC	★ 1491825	VZWD-L-M22C-M-G18-10-V-1P4-50
		2	0 ... 15	300	24 V DC	★ 1491827	VZWD-L-M22C-M-G18-20-V-1P4-15

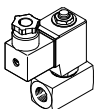
Ordering data							
	Process valve connection	Nominal size DN	Medium pressure <sup>1)</sup> [bar]	Product weight [g]	Operating voltage	Brass housing	
						Part No.	Type
	G 1/4	1	0 ... 50	350	24 V DC	1491828	VZWD-L-M22C-M-G14-10-V-1P4-50
					110 V AC	1491906	VZWD-L-M22C-M-G14-10-V-2AP4-50
					230 V AC	1491984	VZWD-L-M22C-M-G14-10-V-3AP4-50
		1.5	0 ... 30	350	24 V DC	1491829	VZWD-L-M22C-M-G14-15-V-1P4-30
					110 V AC	1491907	VZWD-L-M22C-M-G14-15-V-2AP4-30
					230 V AC	1491985	VZWD-L-M22C-M-G14-15-V-3AP4-30
		2	0 ... 15	350	24 V DC	1491830	VZWD-L-M22C-M-G14-20-V-1P4-15
					110 V AC	1491908	VZWD-L-M22C-M-G14-20-V-2AP4-15
					230 V AC	1491986	VZWD-L-M22C-M-G14-20-V-3AP4-15
		2.5	0 ... 8	350	24 V DC	1491831	VZWD-L-M22C-M-G14-25-V-1P4-8
					110 V AC	1491909	VZWD-L-M22C-M-G14-25-V-2AP4-8
					230 V AC	1491987	VZWD-L-M22C-M-G14-25-V-3AP4-8

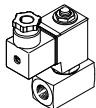
Ordering data							
	Process valve connection	Nominal size DN	Medium pressure <sup>1)</sup> [bar]	Product weight [g]	Operating voltage	Brass housing	
						Part No.	Type
	G 1/8	1	0 ... 50	300	110 V AC	1491903	VZWD-L-M22C-M-G18-10-V-2AP4-50
					230 V AC	1491981	VZWD-L-M22C-M-G18-10-V-3AP4-50
		1.5	0 ... 30	300	24 V DC	1491826	VZWD-L-M22C-M-G18-15-V-1P4-30
					110 V AC	1491904	VZWD-L-M22C-M-G18-15-V-2AP4-30
					230 V AC	1491982	VZWD-L-M22C-M-G18-15-V-3AP4-30
		2	0 ... 15	300	110 V AC	1491905	VZWD-L-M22C-M-G18-20-V-2AP4-15
230 V AC	1491983				VZWD-L-M22C-M-G18-20-V-3AP4-15		

1) The valves are suitable for vacuum with Pabs > 100 mbar. Please ensure the direction of flow corresponds to the direction of the arrow.

Festo core product range

- ★ Generally ready for shipping ex works in 24 hours
- ☆ Generally ready for shipping ex works in 5 days



# Solenoid valves VZWD, directly actuated

Technical data – Brass housing, nominal pressure PN 100

Function

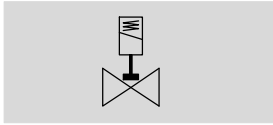

- - Flow rate Kv  
0.06 ... 0.4 m<sup>3</sup>/h

Nominal size (DN)  
1.0 ... 6.0 mm

- - Connecting thread  
G 1/4, G 1/8



General technical data								
Nominal size (DN)	1.0	1.5	2.0	2.5	3.0	4.0	5.0	6.0
Valve function	2/2-way, single solenoid, closed							
Design	Directly actuated poppet valve							
Type of mounting	In-line installation							
Actuation type	Electric							
Reset method	Mechanical spring							
Direction of flow	Non-reversible							
Type of control	Direct							
Manual override	None							
Mounting position	Any							
Sealing principle	Soft							
Max. viscosity [mm <sup>2</sup> /s]	22							
Protection class	IP65							

Operating and environmental conditions								
Nominal size (DN)	1.0	1.5	2.0	2.5	3.0	4.0	5.0	6.0
Standard nominal flow rate [l/min]	60	95	140	170	210	310	375	430
Flow rate Kv [m <sup>3</sup> /h]	0.06	0.09	0.13	0.16	0.2	0.3	0.35	0.4
Process valve nominal pressure (PN)	100							
Pressure differential [bar]	0							
Medium	Compressed air in accordance with ISO 8573-1:2010 [7:4:4]							
	Inert gases							
	Mineral oil							
	Neutral liquids							
	Water							
	Further media upon request							
Ambient temperature [°C]	-10 ... +35 °C							
Temperature of medium [°C]	-10 ... +80 °C							
Leak rate to EN 12266-1	A							
Corrosion resistance class CRC <sup>1)</sup>	1							

1) Corrosion resistance class CRC 1 to Festo standard FN 940070  
Low corrosion stress. For dry indoor applications or transport and storage protection. Also applies to parts behind covers, in the non-visible interior area, and parts which are covered in the application (e.g. drive trunnions).

## Solenoid valves VZWD, directly actuated

FESTO

Technical data – Brass housing, nominal pressure PN 100

Electrical data			
Operating voltage		24 V DC	110 V AC 230 V AC
Electrical connection	Plug to EN 175301-803 type A, square design		
CE marking		–	73/23/EEC 73/23/EEC
Insulation class		H	F F
Duty cycle	[%]	100	
Permissible voltage fluctuations	[%]	±10	
Switching time on	[ms]	20	
Switching time off	[ms]	18	
Coil characteristics			
Direct current DC	[V]	24	– –
Alternating current AC	[V]	–	110 230
Power consumption	[W]	11	– –
Switching power	[VA]	–	19 18
Holding power	[VA]	–	16 15
	[Hz]	–	50, 60 50, 60

Materials		
Solenoid valves		Material number
Housing	High-alloy stainless steel	1.4305
	Brass	CW614N
Seals	FPM	
Note on materials	Contains PWIS (paint-wetting impairment substances)	
	RoHS-compliant	

# Solenoid valves VZWD, directly actuated

Technical data – Brass housing, nominal pressure PN 100

## Dimensions

Download CAD data → [www.festo.com](http://www.festo.com)

Die-cast brass housing

Milled brass housing

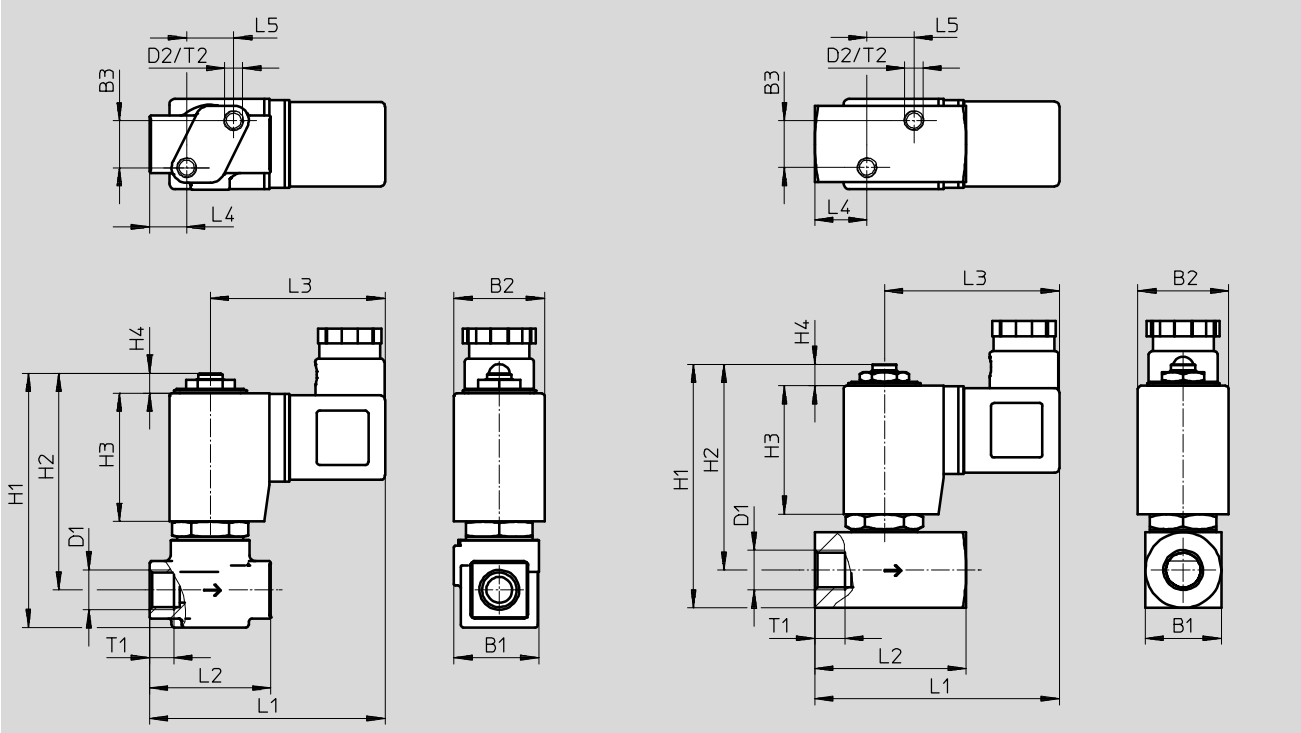

Type	B1	B2	B3	D1	D2	H1	H2	H3	H4	L1	L2	L3	L4	L5	T1	T2
VZWD-...-G1/8-10-...-90	28	30	15.5	G 1/8	M6	84	72	42.5	6.5	78	40	58	12	15.5	8	6
VZWD-...-G1/8-15-...-85																
VZWD-...-G1/8-20-...-40																
VZWD-...-G1/8-25-...-22																
VZWD-...-G1/8-30-...-15																
VZWD-...-G1/8-40-...-8	28	30	15.5	G 1/4	M6	84	72	42.5	6.5	78	40	58	12	15.5	10	6
VZWD-...-G1/4-10-...-90																
VZWD-...-G1/4-15-...-85																
VZWD-...-G1/4-20-...-40																
VZWD-...-G1/4-25-...-22																
VZWD-...-G1/4-30-...-15																
VZWD-...-G1/4-40-...-8	25	30	15.5	G 1/8	M6	81	68	42.5	7	78	40	58	12	15.5	8	6
VZWD-...-G1/8-50-...-5																
VZWD-...-G1/8-60-...-4																
VZWD-...-G1/4-50-...-5																
VZWD-...-G1/4-60-...-4																

# Solenoid valves VZWD, directly actuated

FESTO

Technical data – Brass housing, nominal pressure PN 100

## ★ Core product range

Ordering data							
Process valve connection	Nominal size DN	Medium pressure <sup>1)</sup> [bar]	Product weight [g]	Operating voltage	Brass housing		
					Part No.	Type	
	G 1/4	3	0 ... 15	550	24 V DC	★ 1491844	VZWD-L-M22C-M-G14-30-V-1P4-15
		4	0 ... 8	550	24 V DC	★ 1491845	VZWD-L-M22C-M-G14-40-V-1P4-8

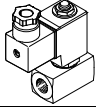
Ordering data							
Process valve connection	Nominal size DN	Medium pressure <sup>1)</sup> [bar]	Product weight [g]	Operating voltage	Brass housing		
					Part No.	Type	
	G 1/4	6	0 ... 4	600	24 V DC	★ 1491847	VZWD-L-M22C-M-G14-60-V-1P4-4

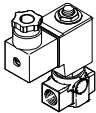
Ordering data							
Process valve connection	Nominal size DN	Medium pressure <sup>1)</sup> [bar]	Product weight [g]	Operating voltage	Brass housing		
					Part No.	Type	
	G 1/8	3	0 ... 15	550	24 V DC	★ 1491836	VZWD-L-M22C-M-G18-30-V-1P4-15
		4	0 ... 8	550	24 V DC	★ 1491837	VZWD-L-M22C-M-G18-40-V-1P4-8

Ordering data							
Process valve connection	Nominal size DN	Medium pressure <sup>1)</sup> [bar]	Product weight [g]	Operating voltage	Brass housing		
					Part No.	Type	
	G 1/4	1	0 ... 90	550	24 V DC	1491840	VZWD-L-M22C-M-G14-10-V-1P4-90
					110 V AC	1491918	VZWD-L-M22C-M-G14-10-V-2AP4-90
					230 V AC	1491996	VZWD-L-M22C-M-G14-10-V-3AP4-90
		1.5	0 ... 85	550	24 V DC	1491841	VZWD-L-M22C-M-G14-15-V-1P4-85
					110 V AC	1491919	VZWD-L-M22C-M-G14-15-V-2AP4-85
					230 V AC	1491997	VZWD-L-M22C-M-G14-15-V-3AP4-85
		2	0 ... 40	550	24 V DC	1491842	VZWD-L-M22C-M-G14-20-V-1P4-40
					110 V AC	1491920	VZWD-L-M22C-M-G14-20-V-2AP4-40
					230 V AC	1491998	VZWD-L-M22C-M-G14-20-V-3AP4-40
	2.5	0 ... 22	550	24 V DC	1491843	VZWD-L-M22C-M-G14-25-V-1P4-22	
				110 V AC	1491921	VZWD-L-M22C-M-G14-25-V-2AP4-22	
				230 V AC	1491999	VZWD-L-M22C-M-G14-25-V-3AP4-22	
	3	0 ... 15	550	110 V AC	1491922	VZWD-L-M22C-M-G14-30-V-2AP4-15	
				230 V AC	1492000	VZWD-L-M22C-M-G14-30-V-3AP4-15	
	4	0 ... 8	550	110 V AC	1491923	VZWD-L-M22C-M-G14-40-V-2AP4-8	
				230 V AC	1492001	VZWD-L-M22C-M-G14-40-V-3AP4-8	

1) The valves are suitable for vacuum with Pabs > 100 mbar. Please ensure the direction of flow corresponds to the direction of the arrow.

Festo core product range      ★ Generally ready for shipping ex works in 24 hours  
 ☆ Generally ready for shipping ex works in 5 days

# Solenoid valves VZWD, directly actuated

Technical data – Brass housing, nominal pressure PN 100

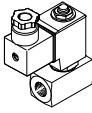
Ordering data							
	Process valve connection	Nominal size DN	Medium pressure <sup>1)</sup> [bar]	Product weight [g]	Operating voltage	Brass housing	
						Part No.	Type
	G 1/4	5	0 ... 5	600	24 V DC	<b>1491846</b>	VZWD-L-M22C-M-G14-50-V-1P4-5
					110 V AC	<b>1491924</b>	VZWD-L-M22C-M-G14-50-V-2AP4-5
					230 V AC	<b>1492002</b>	VZWD-L-M22C-M-G14-50-V-3AP4-5
		6	0 ... 4	600	110 V AC	<b>1491925</b>	VZWD-L-M22C-M-G14-60-V-2AP4-4
					230 V AC	<b>1492003</b>	VZWD-L-M22C-M-G14-60-V-3AP4-4

Ordering data							
	Process valve connection	Nominal size DN	Medium pressure <sup>1)</sup> [bar]	Product weight [g]	Operating voltage	Brass housing	
						Part No.	Type
	G 1/8	1	0 ... 90	550	24 V DC	<b>1491832</b>	VZWD-L-M22C-M-G18-10-V-1P4-90
					110 V AC	<b>1491910</b>	VZWD-L-M22C-M-G18-10-V-2AP4-90
					230 V AC	<b>1491988</b>	VZWD-L-M22C-M-G18-10-V-3AP4-90
		1.5	0 ... 85	550	24 V DC	<b>1491833</b>	VZWD-L-M22C-M-G18-15-V-1P4-85
					110 V AC	<b>1491911</b>	VZWD-L-M22C-M-G18-15-V-2AP4-85
					230 V AC	<b>1491989</b>	VZWD-L-M22C-M-G18-15-V-3AP4-85
		2	0 ... 40	550	24 V DC	<b>1491834</b>	VZWD-L-M22C-M-G18-20-V-1P4-40
					110 V AC	<b>1491912</b>	VZWD-L-M22C-M-G18-20-V-2AP4-40
					230 V AC	<b>1491990</b>	VZWD-L-M22C-M-G18-20-V-3AP4-40
		2.5	0 ... 22	550	24 V DC	<b>1491835</b>	VZWD-L-M22C-M-G18-25-V-1P4-22
					110 V AC	<b>1491913</b>	VZWD-L-M22C-M-G18-25-V-2AP4-22
					230 V AC	<b>1491991</b>	VZWD-L-M22C-M-G18-25-V-3AP4-22
		3	0 ... 15	550	110 V AC	<b>1491914</b>	VZWD-L-M22C-M-G18-30-V-2AP4-15
					230 V AC	<b>1491992</b>	VZWD-L-M22C-M-G18-30-V-3AP4-15
		4	0 ... 8	550	110 V AC	<b>1491915</b>	VZWD-L-M22C-M-G18-40-V-2AP4-8
					230 V AC	<b>1491993</b>	VZWD-L-M22C-M-G18-40-V-3AP4-8

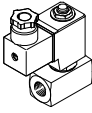
Ordering data							
	Process valve connection	Nominal size DN	Medium pressure <sup>1)</sup> [bar]	Product weight [g]	Operating voltage	Brass housing	
						Part No.	Type
	G 1/8	5	0 ... 5	600	24 V DC	<b>1491838</b>	VZWD-L-M22C-M-G18-50-V-1P4-5
					110 V AC	<b>1491916</b>	VZWD-L-M22C-M-G18-50-V-2AP4-5
					230 V AC	<b>1491994</b>	VZWD-L-M22C-M-G18-50-V-3AP4-5
		6	0 ... 4	600	24 V DC	<b>1491839</b>	VZWD-L-M22C-M-G18-60-V-1P4-4
					110 V AC	<b>1491917</b>	VZWD-L-M22C-M-G18-60-V-2AP4-4
					230 V AC	<b>1491995</b>	VZWD-L-M22C-M-G18-60-V-3AP4-4

1) The valves are suitable for vacuum with Pabs > 100 mbar. Please ensure the direction of flow corresponds to the direction of the arrow.

# Solenoid valves VZWD, directly actuated

Technical data – Stainless steel housing, nominal pressure PN 100

FESTO

Function

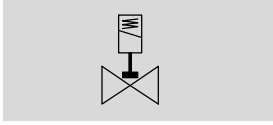

-  - Flow rate Kv  
0.06 ... 0.4 m<sup>3</sup>/h

-  - Connecting thread  
G 1/4, G 1/8



General technical data								
Nominal size (DN)	1.0	1.5	2.0	2.5	3.0	4.0	5.0	6.0
Valve function	2/2-way, single solenoid, closed							
Design	Directly actuated poppet valve							
Type of mounting	In-line installation							
Actuation type	Electric							
Reset method	Mechanical spring							
Type of control	Direct							
Manual override	None							
Mounting position	Any							
Sealing principle	Soft							
Direction of flow	Non-reversible							
Max. viscosity [mm <sup>2</sup> /s]	22							
Protection class	IP65							

Operating and environmental conditions								
Nominal size (DN)	1.0	1.5	2.0	2.5	3.0	4.0	5.0	6.0
Standard nominal flow rate [l/min]	60	95	140	170	210	310	375	430
Flow rate Kv [m <sup>3</sup> /h]	0.06	0.09	0.13	0.16	0.2	0.3	0.35	0.4
Process valve nominal pressure (PN)	100							
Medium	Compressed air in accordance with ISO 8573-1:2010 [7:4:4]							
	Inert gases							
	Mineral oil							
	Neutral liquids							
	Water							
	Further media upon request							
Pressure differential [bar]	0							
Ambient temperature [°C]	-10 ... +35 °C							
Temperature of medium [°C]	-10 ... +80 °C							
Leak rate to EN 12266-1	A							
Corrosion resistance class CRC <sup>1)</sup>	3							

1) Corrosion resistance class CRC 3 to Festo standard FN 940070

High corrosion stress. Outdoor exposure under moderate corrosive conditions. External visible parts with primarily functional requirements for the surface and which are in direct contact with a normal industrial environment.

## Solenoid valves VZWD, directly actuated

FESTO

Technical data – Stainless steel housing, nominal pressure PN 100

Electrical data				
Operating voltage		24 V DC	110 V AC	230 V AC
Electrical connection		Plug to EN 175301-803 type A, square design		
CE marking		–	73/23/EEC	73/23/EEC
Insulation class		H	F	F
Duty cycle	[%]	100		
Permissible voltage fluctuations	[%]	±10		
Switching time on	[ms]	20		
Switching time off	[ms]	18		
Coil characteristics				
Direct current DC	[V]	24	–	–
Alternating current AC	[V]	–	110	230
Power consumption	VACS-H0P [W]	6.8	–	–
solenoid coil type	VACS-H1P [W]	11	–	–
Switching power	VACS-H0P [VA]	–	10.5	10.5
solenoid coil type	VACS-H1P [VA]	–	19	18
Holding power	VACS-H0P [VA]	–	8	7.6
solenoid coil type	VACS-H1P [VA]	–	16	15
	[Hz]	–	50, 60	50, 60

Materials		
Solenoid valves		Material number
Housing	High-alloy stainless steel	1.4305
Seals	FPM	
Note on materials	Contains PWIS (paint-wetting impairment substances)	
	RoHS-compliant	

# Solenoid valves VZWD, directly actuated

Technical data – Stainless steel housing, nominal pressure PN 100

## Dimensions

Download CAD data → [www.festo.com](http://www.festo.com)

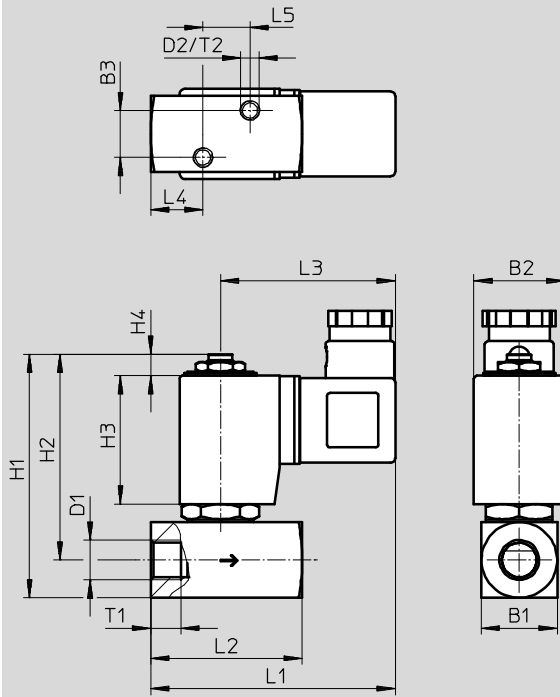

Type	B1	B2	B3	D1	D2	H1	H2	H3	H4	L1	L2	L3	L4	L5	T1	T2
VZWD-...-G1/8-50-...-5	25	30	15.5	G 1/8	M6	81	68	42.5	7	78	40	58	12	15.5	8	6
VZWD-...-G1/8-60-...-4																
VZWD-...-G1/4-50-...-5	25	30	15.5	G 1/4	M6	81	68	42.5	7	85	50	58	17	15.5	10	6
VZWD-...-G1/4-60-...-4																



# Solenoid valves VZWD, directly actuated

Technical data – Stainless steel housing, nominal pressure PN 100

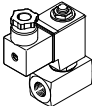
Ordering data – Solenoid valve VZWD										
	Process valve connection	Nominal size DN	Medium pressure <sup>1)</sup> [bar]	Product weight [g]	Operating voltage	Stainless steel casting housing				
						Part No.	Type			
	G 1/4	1	0 ... 90	650	24 V DC	1491856	VZWD-L-M22C-M-G14-10-V-1P4-90-R1			
					110 V AC	1491934	VZWD-L-M22C-M-G14-10-V-2AP4-90-R1			
					230 V AC	1492012	VZWD-L-M22C-M-G14-10-V-3AP4-90-R1			
					1.5	0 ... 85	650	24 V DC	1491857	VZWD-L-M22C-M-G14-10-V-1P4-90-R1
								110 V AC	1491935	VZWD-L-M22C-M-G14-15-V-2AP4-85-R1
								230 V AC	1492013	VZWD-L-M22C-M-G14-15-V-3AP4-85-R1
					2	0 ... 40	650	24 V DC	1491858	VZWD-L-M22C-M-G14-20-V-1P4-40-R1
								110 V AC	1491936	VZWD-L-M22C-M-G14-20-V-2AP4-40-R1
								230 V AC	1492014	VZWD-L-M22C-M-G14-20-V-3AP4-40-R1
		2.5	0 ... 22	650	24 V DC	1491859	VZWD-L-M22C-M-G14-25-V-1P4-22-R1			
					110 V AC	1491937	VZWD-L-M22C-M-G14-25-V-2AP4-22-R1			
					230 V AC	1492015	VZWD-L-M22C-M-G14-25-V-3AP4-22-R1			
		3	0 ... 15	650	24 V DC	1491860	VZWD-L-M22C-M-G14-30-V-1P4-15-R1			
					110 V AC	1491938	VZWD-L-M22C-M-G14-30-V-2AP4-15-R1			
					230 V AC	1492016	VZWD-L-M22C-M-G14-30-V-3AP4-15-R1			
		4	0 ... 8	650	24 V DC	1491861	VZWD-L-M22C-M-G14-40-V-1P4-8-R1			
					110 V AC	1491939	VZWD-L-M22C-M-G14-40-V-2AP4-8-R1			
					230 V AC	1492017	VZWD-L-M22C-M-G14-40-V-3AP4-8-R1			
		5	0 ... 5	650	24 V DC	1491862	VZWD-L-M22C-M-G14-50-V-1P4-5-R1			
					110 V AC	1491940	VZWD-L-M22C-M-G14-50-V-2AP4-5-R1			
					230 V AC	1492018	VZWD-L-M22C-M-G14-50-V-3AP4-5-R1			
		6	0 ... 4	650	24 V DC	1491863	VZWD-L-M22C-M-G14-60-V-1P4-4-R1			
					110 V AC	1491941	VZWD-L-M22C-M-G14-60-V-2AP4-4-R1			
					230 V AC	1492019	VZWD-L-M22C-M-G14-60-V-3AP4-4-R1			

1) The valves are suitable for vacuum with Pabs > 100 mbar. Please ensure the direction of flow corresponds to the direction of the arrow.

# Solenoid valves VZWD, directly actuated

Technical data – Stainless steel housing, nominal pressure PN 100

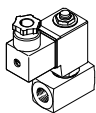
Ordering data – Solenoid valve VZWD							
	Process valve connection	Nominal size DN	Medium pressure <sup>1)</sup> [bar]	Product weight [g]	Operating voltage	Stainless steel casting housing	
						Part No.	Type
	G 1/8	1	0 ... 90	500	24 V DC	1491848	VZWD-L-M22C-M-G18-10-V-1P4-90-R1
					110 V AC	1491926	VZWD-L-M22C-M-G18-10-V-2AP4-90-R1
					230 V AC	1492004	VZWD-L-M22C-M-G18-10-V-3AP4-90-R1
		1.5	0 ... 85	500	24 V DC	1491849	VZWD-L-M22C-M-G18-15-V-1P4-85-R1
					110 V AC	1491927	VZWD-L-M22C-M-G18-15-V-2AP4-85-R1
					230 V AC	1492005	VZWD-L-M22C-M-G18-15-V-3AP4-85-R1
		2	0 ... 40	500	24 V DC	1491850	VZWD-L-M22C-M-G18-20-V-1P4-40-R1
					110 V AC	1491928	VZWD-L-M22C-M-G18-20-V-2AP4-40-R1
					230 V AC	1492006	VZWD-L-M22C-M-G18-20-V-3AP4-40-R1
		2.5	0 ... 22	500	24 V DC	1491851	VZWD-L-M22C-M-G18-25-V-1P4-22-R1
					110 V AC	1491929	VZWD-L-M22C-M-G18-25-V-2AP4-22-R1
					230 V AC	1492007	VZWD-L-M22C-M-G18-25-V-3AP4-22-R1
		3	0 ... 15	500	24 V DC	1491852	VZWD-L-M22C-M-G18-30-V-1P4-15-R1
					110 V AC	1491930	VZWD-L-M22C-M-G18-30-V-2AP4-15-R1
					230 V AC	1492008	VZWD-L-M22C-M-G18-30-V-3AP4-15-R1
		4	0 ... 8	500	24 V DC	1491853	VZWD-L-M22C-M-G18-40-V-1P4-8-R1
					110 V AC	1491931	VZWD-L-M22C-M-G18-40-V-2AP4-8-R1
					230 V AC	1492009	VZWD-L-M22C-M-G18-40-V-3AP4-8-R1
		5	0 ... 5	500	24 V DC	1491854	VZWD-L-M22C-M-G18-50-V-1P4-5-R1
					110 V AC	1491932	VZWD-L-M22C-M-G18-50-V-2AP4-5-R1
					230 V AC	1492010	VZWD-L-M22C-M-G18-50-V-3AP4-5-R1
		6	0 ... 4	500	24 V DC	1491855	VZWD-L-M22C-M-G18-60-V-1P4-4-R1
					110 V AC	1491933	VZWD-L-M22C-M-G18-60-V-2AP4-4-R1
					230 V AC	1492011	VZWD-L-M22C-M-G18-60-V-3AP4-4-R1

1) The valves are suitable for vacuum with Pabs > 100 mbar. Please ensure the direction of flow corresponds to the direction of the arrow.